

HISTÓRIA

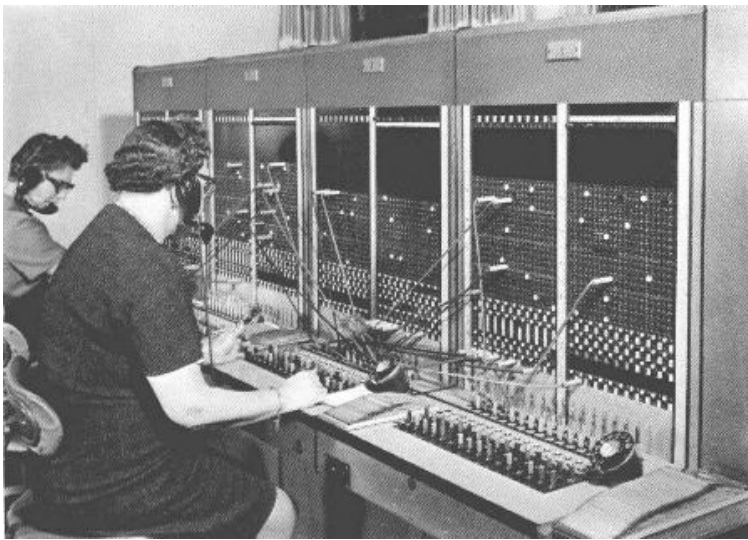

AUTOMATIZÁCIA TELEFÓNNYCH PREPÁJANÍ

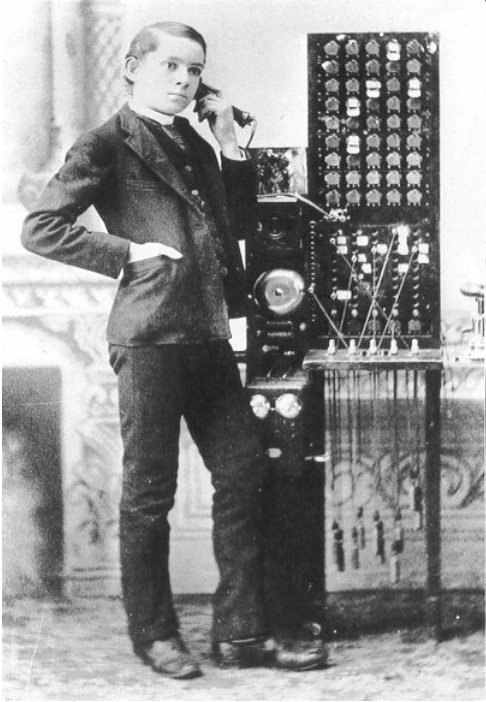
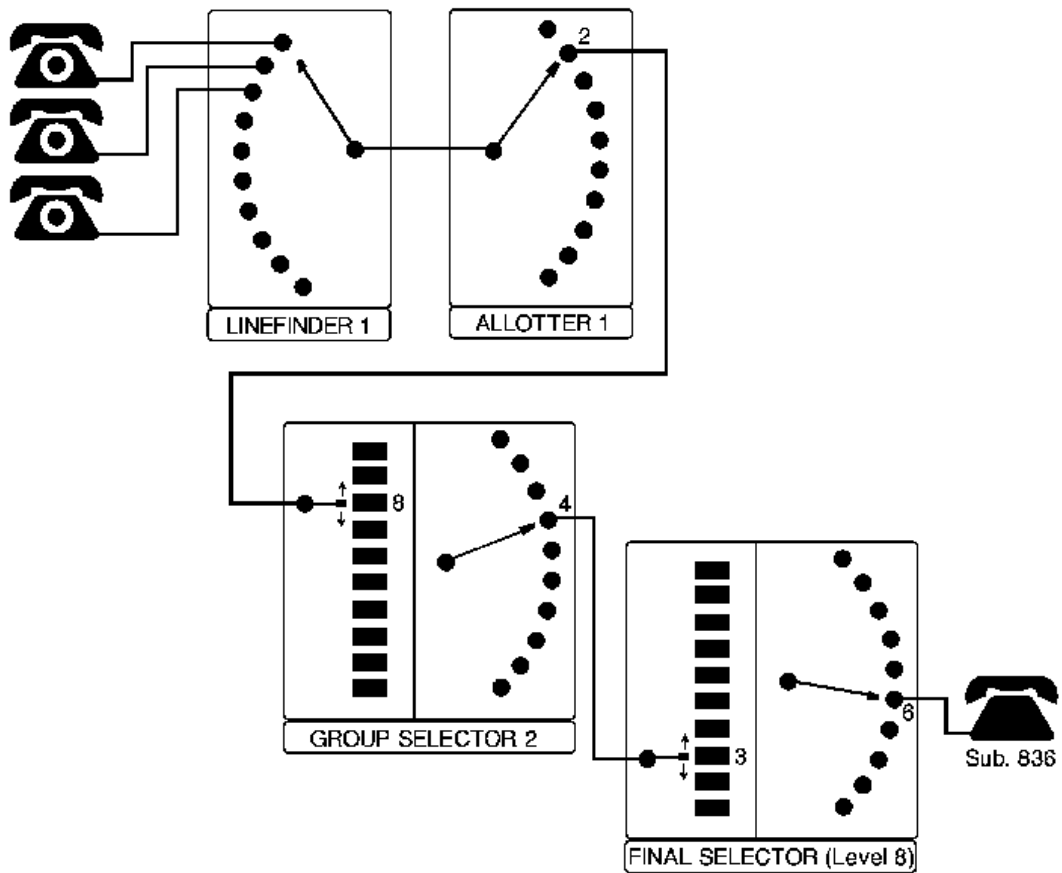

(No Model.)

3 Sheets—Sheet 1.

A. B. STROWGER.
AUTOMATIC TELEPHONE EXCHANGE.

No. 447,918.

Patented Mar. 10, 1891.

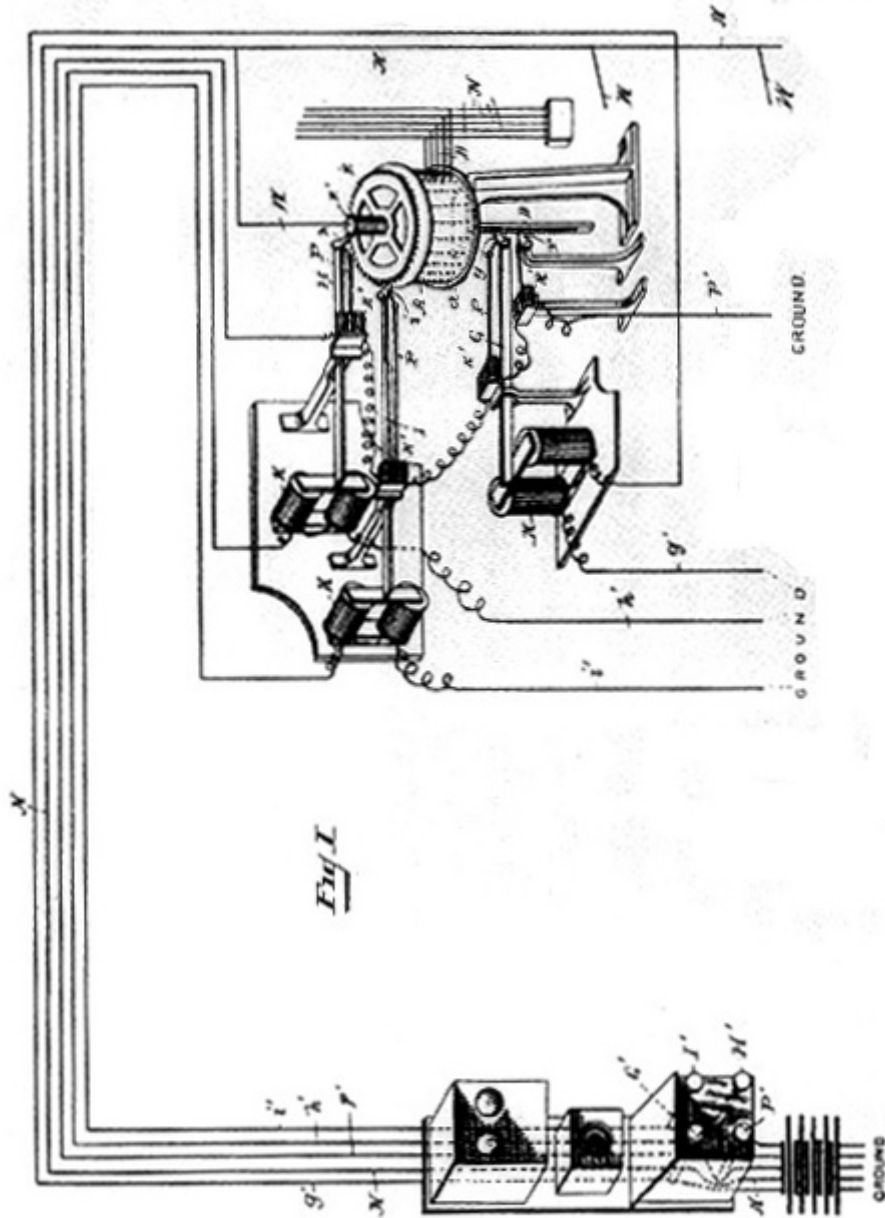

Fig. 1

Witnesses:

R. C. Balderson
A. B. Strowger

Inventor:

Almon B. Strowger

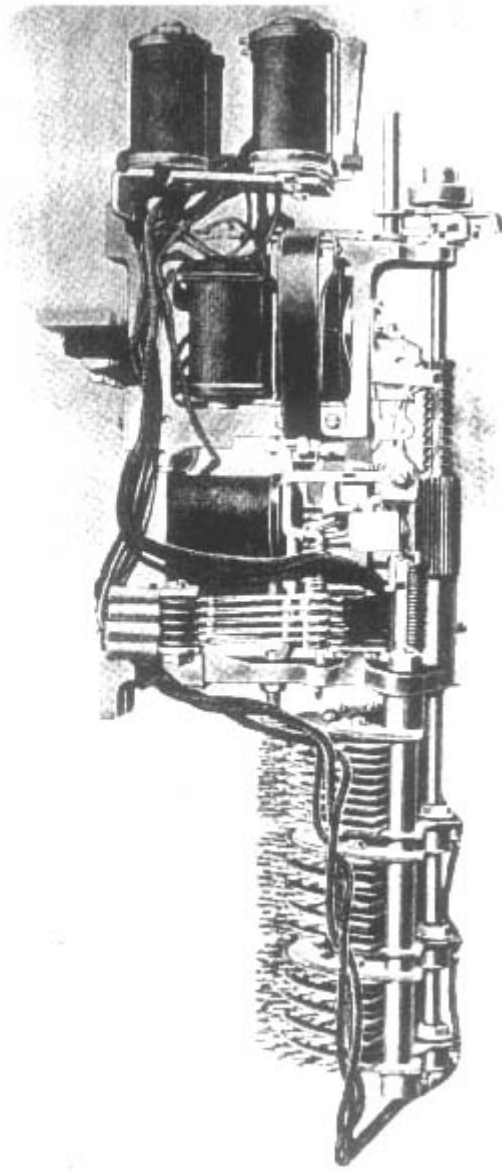
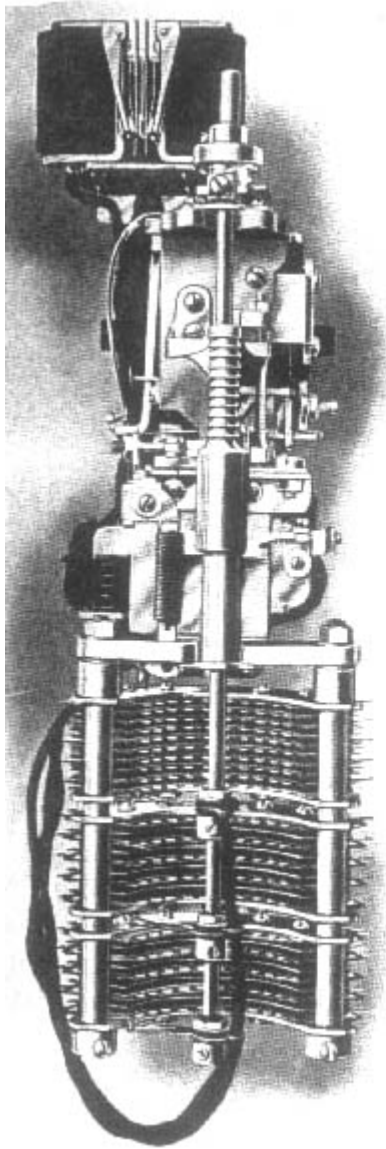

Strowger Exchange



strowger - ústředňa

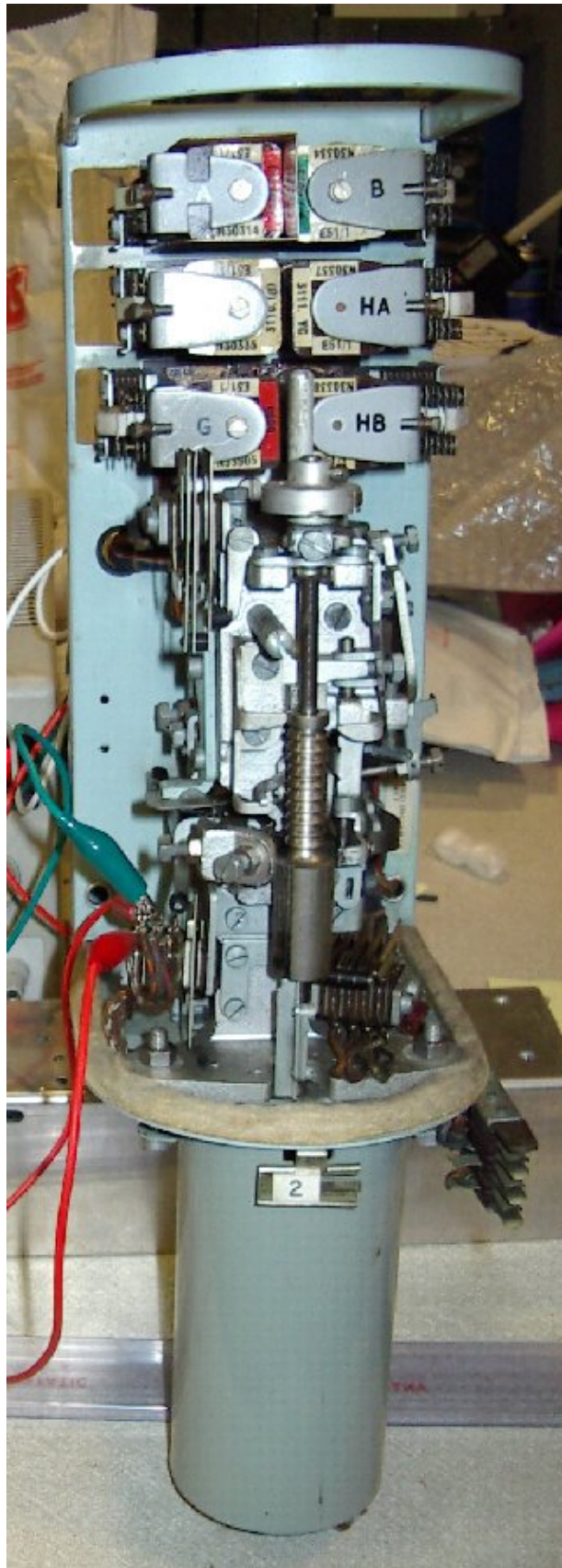

SKUPINÁR

